









Enlarged to show pattern

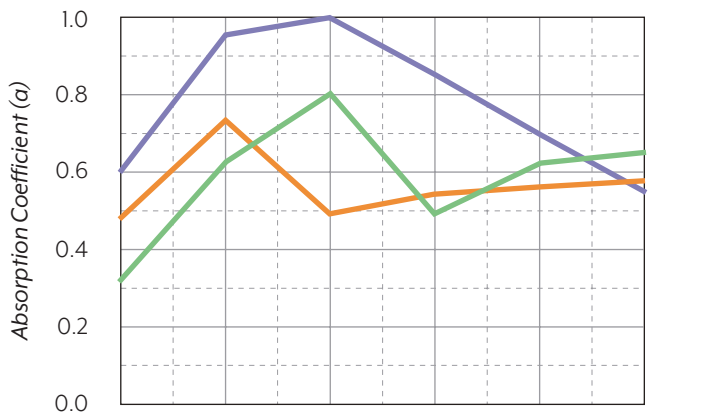

Sonus panels are high density gypsum board with continuous sound absorbing perforations for a monolithic appearance. They can be used on ceilings, walls and special applications where noise reduction is critical. Sonus panels come in many perforation designs, some with random patterns, some with sequential patterns. The perforated board absorbs and diffuses sound that would otherwise reflect back into the room.

## PERFORMANCE

-  **A 2-s1, d0 (non-flammable) according to DIN EN 13501**
-  **Maximum Relative Humidity: 70%**
-  **Recycled Content: 86% (3% Post Consumer)**
-  **NRC: Up to .90**



	125	250	500	1,000	2,000	4,000
	0.31	0.62	0.80	0.50	0.61	0.64
	0.49	0.72	0.50	0.54	0.56	0.58
	0.60	0.95	1.00	0.85	0.70	0.55

-  Cavity Depth = 200mm (~8")
-  Cavity Depth = 400mm (~16")
-  Cavity Depth = 200mm (~8") with 50mm (~2") Fiberglass

## SONUS ROUND 15/30

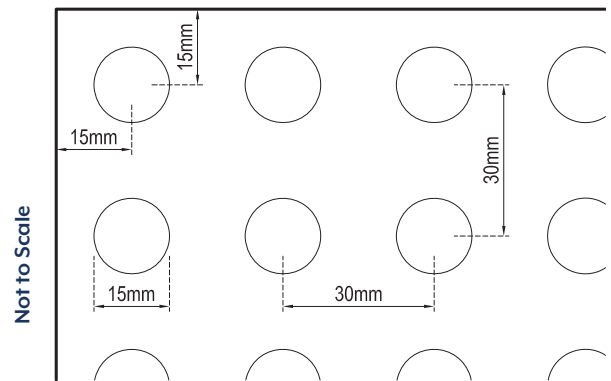

## CHARACTERISTICS

Perforation type:	15mm (30mm o.c.)
Board Thickness:	1/2" (12.5mm)
Non-woven Fabric Backing:	Charcoal Gray
Finish:	Unfinished paper face
Open Area:	19.6%
Weight:	1.82 lbs / s.f.

## AVAILABLE BOARD SIZES

1200mm x 1980mm (~47.24" x 77.95")

1200mm x 2400mm (~47.24" x 94.49")



Joints are filled with GypSorb joint filler then skimmed over with standard finishing compound. Once dry, the joints are sanded smooth in order to receive prime and paint. See Sonus/Strata Installation Principles for further information.