

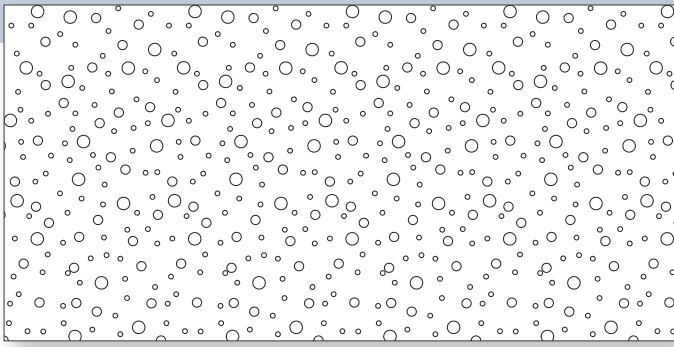



Strata







Enlarged to show pattern

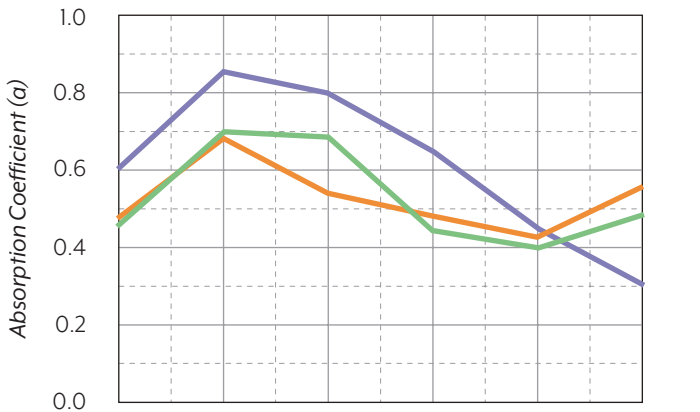

Strata panels are high density gypsum board with continuous sound absorbing perforations. They can be used on ceilings, walls and special applications where noise reduction is critical and architectural design is unique. The random round perforations create a dramatic visual element that is easier to use on curves and bends where a straight line pattern may not look as nice.

PERFORMANCE

-  **A 2-s1, d0 (non-flammable) according to DIN EN 13501**
-  **Maximum Relative Humidity: 70%**
-  **Recycled Content: 86% (3% Post Consumer)**
-  **NRC: Up to .70**



| | 125 | 250 | 500 | 1,000 | 2,000 | 4,000Hz |
|---|------|------|------|-------|-------|---------|
|  | 0.45 | 0.70 | 0.69 | 0.44 | 0.40 | 0.49 |
|  | 0.47 | 0.69 | 0.53 | 0.49 | 0.43 | 0.55 |
|  | 0.60 | 0.85 | 0.80 | 0.65 | 0.45 | 0.30 |

-  Cavity Depth = 200mm (~8")
-  Cavity Depth = 400mm (~16")
-  Cavity Depth = 200mm (~8") with 50mm (~2") Fiberglass

STRATA 8-15-20

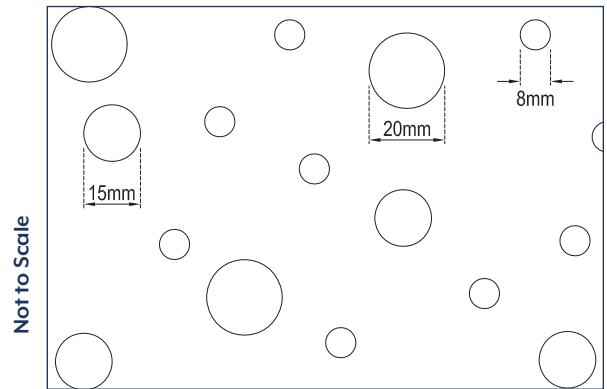

CHARACTERISTICS

| | |
|---------------------------|-----------------------|
| Perforation type: | 8-15-20mm |
| Board Thickness: | 1/2" (12.5mm) |
| Non-woven Fabric Backing: | Charcoal Gray |
| Finish: | Unfinished paper face |
| Open Area: | 9.8% |
| Weight: | 2.05 lbs / s.f. |

AVAILABLE BOARD SIZES

- 1200mm x 2000mm (~47.24" x 78.74")
- 1200mm x 2500mm (~47.24" x 98.43")



Joints are filled with GypSorb joint filler then skimmed over with standard finishing compound. Once dry, the joints are sanded smooth in order to receive prime and paint. See Sonus/Strata Installation Principles for further information.